







FMI125N

Usable volume	25 l
	
Product Family	Microwave
Category	Built-in
Installation	Fully Built-in
Power supply	Electric
Cooking Method	Microwave with grill
Control	Electronic



Programme / Functions

No. of functions	6
Full grill	
Pizza	
Defrost by time	
Defrost by weight	
Microwave	
Microwave + grill	
Automatic programmes	8

Controls

	Display / Clock	TFT	Opening	Electrical button
	Type of control setting	Touch control		

Options

	Timer	Electronic	End of cooking acoustic alarm	Yes
	Time-setting options	End cooking		

Controls Lock / Child Safety Yes

Technical Features

Cavity material	Stainless steel	Door opening	Side-opening
No. of lights	1	Total no. of door glasses	1
Light type	Incandescent	Safety Thermostat	Yes
Turntable	Yes	Cooling system	Tangential
Turntable dimensions	31.5 cm	Microwave stops when door is opened	Yes
Light when door is opened	Yes	Usable cavity space dimensions (HxWxD)	334x370x221 mm
Grill type	Quartz	Microwave effective power	900 W
Grill - power	1000 W		

Accessories Included

Grid	1	Other	Suction cup
-------------	---	--------------	-------------

Electrical Connection

Nominal power	1450 W	Frequency (Hz)	50 Hz
Current	6.3 A	Power supply cable length	130 cm
Voltage (V)	230 V		

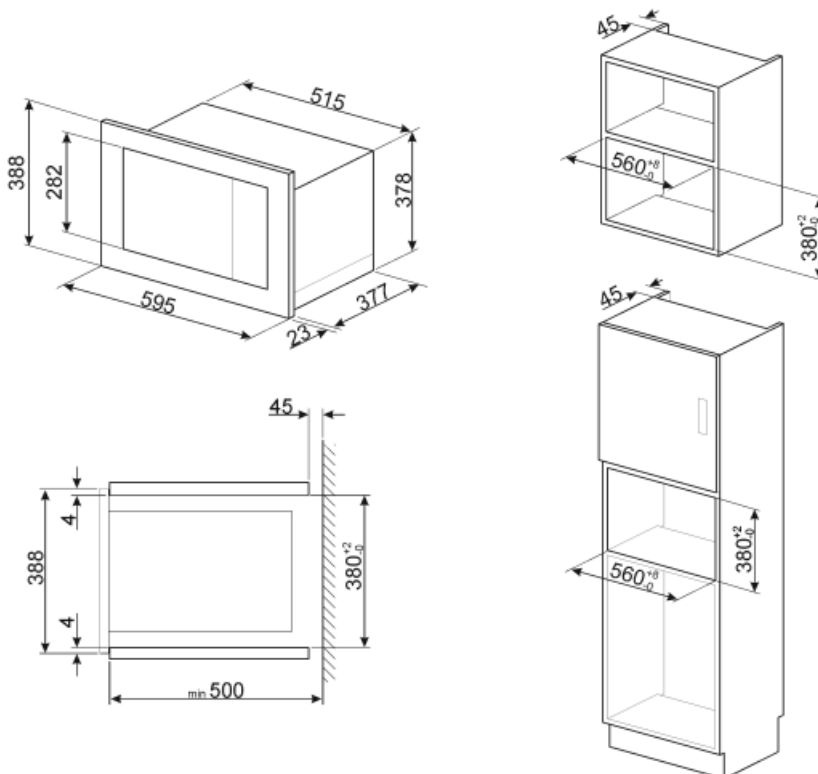











Not included accessories

KITPLATE



The dish baker is a Teflon-coated aluminum plate with the lower part of ferrous material immersed in a silicone rubber 26,5 cm edges of the flare, 25 cm base

Symbols glossary (TT)

- | | | | |
|--|---|---|--|
|  | Child lock: some models are fitted with a device to lock the programme/cycle so it cannot be accidentally changed. |  | Microwave energy shortens cooking times dramatically and produces energy savings. |
|  | Defrost by time: Manual defrost function. At the end of the set duration, the function stops. |  | Defrost by weight: Automatic defrost function. You choose the type of food to defrost from the available categories (MEAT - FISH - BREAD - DESSERTS) After entering the weight of the food, the oven automatically defines the time required for proper defrosting. |
|  | Grill: Very intense heat coming only from above from a double heating element. The fan is not active. Provides excellent grilling and gratinating results. Used at the end of cooking, it gives a uniform browning to dishes. |  | Microwave: Penetrating straight into the food, microwaves cook very quickly and with considerable energy savings. Suitable for cooking without fat, they are also able to thaw and heat food without altering its original appearance and aroma. The microwave function can also be combined with conventional functions with all the resulting advantages. Ideal for all types of food. |
|  | Microwave + grill element: The use of the grill results in a perfect browning of the surface of the food. The action of microwaves allows instead of cooking in a short time the internal part of the food. |  | Pizza microwave: This function cooks pizza quicker thanks to the microwaves. To optimize the final result, use the function combined with the Chef plate |
|  | Touch controls: Easy to use touch controls allow the appliance to be programmed at the touch of a button. |  | The capacity indicates the amount of usable space in the oven cavity in litres. |