

MP722PO

Usable volume

22 l



Product Family

Microwave

Category

Built-in

Installation

Under cupboard

Power supply

Electric

Cooking Method

Microwave with grill

Control

Electronic



Programme / Functions

No. of functions

6

Full grill



Pizza



Defrost by time



Defrost by weight



Microwave



Microwave + grill



Controls

Display / Clock

1 a LED

No. of controls

2

Type of control setting

Control knobs

Control knobs

Cortina

Opening

Mechanical button

Controls colour

Cream

Options



Timer

Electronic

Showroom demo option

Yes

Time-setting options

Start and stop

Controls Lock / Child

Yes

End of cooking acoustic alarm

Yes

Safety

Technical Features



Cavity material	Stainless steel	Door opening	Side-opening
No. of lights	1	Total no. of door glasses	2
Light type	Incandescent	Safety Thermostat	Yes
Light Power	20 W	Cooling system	Tangential
Ceramic base	Yes	Microwave screen protection	Yes
Light when door is opened	Yes	Microwave stops when door is opened	Yes
Grill type	Heating element	Usable cavity space dimensions (HxWxD)	220x350x280 mm
Tilting grill	Yes	Microwave effective power	850 W
Grill - power	1250 W		

Accessories Included

Grid 1

Electrical Connection

Nominal power	2700 W	Frequency (Hz)	50 Hz
Current	11 A	Power supply cable length	150 cm
Voltage (V)	220-240 V		

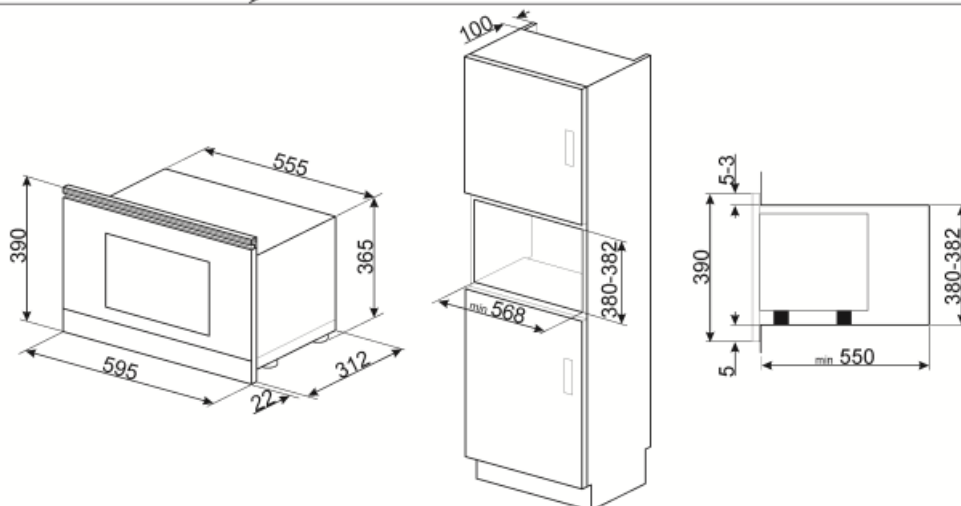
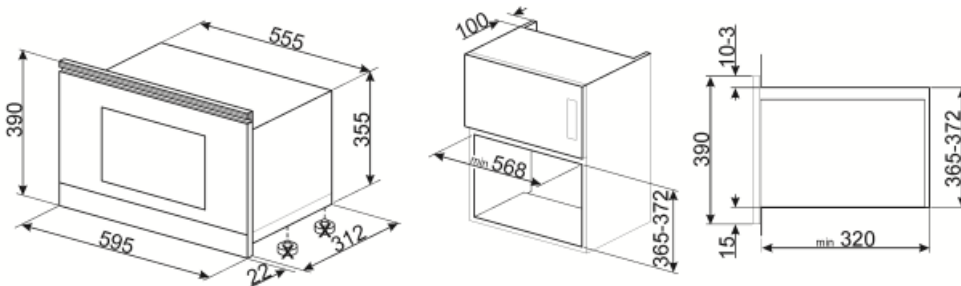

Not included accessories



KITMP38













Thin bar to change microwave ovens height from 39cm to 38cm



KITPLATE

The dish baker is a Teflon-coated aluminum plate with the lower part of ferrous material immersed in a silicone rubber 26,5 cm edges of the flare, 25 cm base

Symbols glossary (TT)

 <p>Surfaceplus ceramic base: Surfaceplus ceramic base for a microwave oven - no turntable required, and the whole surface can be used for cooking.</p>	 <p>Child lock: some models are fitted with a device to lock the programme/cycle so it cannot be accidentally changed.</p>
 <p>Microwave energy shortens cooking times dramatically and produces energy savings.</p>	 <p>Defrost by time: Manual defrost function. At the end of the set duration, the function stops.</p>
 <p>Defrost by weight: Automatic defrost function. You choose the type of food to defrost from the available categories (MEAT - FISH - BREAD - DESSERTS) After entering the weight of the food, the oven automatically defines the time required for proper defrosting.</p>	 <p>Double glazed doors: Number of glazed doors.</p>
 <p>Grill: Very intense heat coming only from above from a double heating element. The fan is not active. Provides excellent grilling and gratinating results. Used at the end of cooking, it gives a uniform browning to dishes.</p>	 <p>Microwave: Penetrating straight into the food, microwaves cook very quickly and with considerable energy savings. Suitable for cooking without fat, they are also able to thaw and heat food without altering its original appearance and aroma. The microwave function can also be combined with conventional functions with all the resulting advantages. Ideal for all types of food.</p>
 <p>Microwave + grill element: The use of the grill results in a perfect browning of the surface of the food. The action of microwaves allows instead of cooking in a short time the internal part of the food.</p>	 <p>Pizza microwave: This function cooks pizza quicker thanks to the microwaves. To optimize the final result, use the function combined with the Chef plate</p>
 <p>Tilting grill: the tilting grill can be easily unhooked to move the heating element and clean the roof of the appliance in one simple step.</p>	 <p>The capacity indicates the amount of usable space in the oven cavity in litres.</p>