

HR

EN

UPUTE ZA UPORABU

USER MANUAL

**ELEKTRIČNO STAKLOKERAMIČKO
UGRADBENO KUHALO**

**ELECTRIC VITROCERAMIC
BUILT-IN HOB**

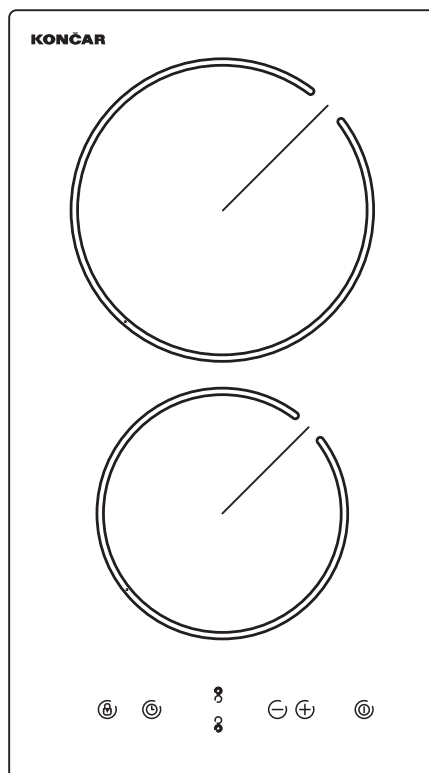

UK302KM

KONČAR

UPUTE ZA UPORABU

ŠTOVANI KUPCI,

zahvaljujemo Vam na povjerenju koje ste nam ukazali kupnjom našeg proizvoda.



Za vaše lakše snalaženje pri uporabi proizvoda pripremili smo ove upute za uporabu.

Molimo vas da ih pomno pročitate jer ćete tako izbjeći greške, povećati uporabno trajanje proizvoda, štedjeti energiju i novac.

Upute su dostupne na web adresi: www.koncar-ka.hr

Upute za uporabu odložite na sigurno mjesto kako bi ih mogli koristiti i za buduće potrebe. Ako aparat prodate ili ustupite drugom vlasniku tada uz aparat priložite i ove upute.



POZOR! VRUĆA POVRŠINA!



POZOR! OPASNOST OD POŽARA!

ZAŠTITA OKOLIŠA

Ambalaža je izrađena tako da ne ugrožava okoliš; ambalažni materijal je ekološki i može se preraditi, odnosno reciklirati. Recikliranjem ambalaže štedi se na sirovinama i smanjuje količina industrijskog i kućanskog otpada.



Sukladno Direktivi o otpadnoj električnoj i elektroničkoj opremi (WEEE) Europske unije, otpadna električna i elektronička oprema treba se odvojeno sakupljati i zbrinjavati. Simbol s lijeve strane znači da se električni i elektronički aparati na kraju njihova uporabnog vijeka ne smiju odbacivati zajedno s ostalim kućnim otpadom. Molimo da ovaj aparat predate lokalnoj tvrtki koja se bavi zbrinjavanjem otpada ili ga odnosi u reciklažno dvorište.

Korisnik ne smije rastavljati aparat ili ostale komponenete. Taj posao obavlja ovlaštena tvrtka koja se bavi recikliranjem takve vrste otpada.

CE Aparati su ispitani i certificirani prema postojećim europskim normama za kućanske aparate. Ovaj proizvod je u skladu s EU normama.

	<p>Ovaj aparat je namijenjen isključivo za uporabu u domaćinstvu i nije namijenjen uporabi u profesionalne (komercijalne) svrhe ili namjene koje nadilaze uobičajenu uporabu u domaćinstvu. Ako se aparat ipak tako upotrebljava, tada proizvođač ne snosi nikakvu odgovornost, a jamstvo ne vrijedi.</p> <p>Proizvođač ne snosi nikakvu odgovornost za ozljede ili oštećenja izazvana nepravilnim postavljanjem ili uporabom te ne priznaje pravo na jamstvo u slučaju ne pridržavanja gore navedenih uputa.</p> <p>Proizvođač zadržava pravo promijeniti konstrukciju, mjere i težinu ako to smatra potrebnim radi poboljšanja kvalitete proizvoda, bez ugrožavanja osnovnih svojstava proizvoda.</p>
---	---

	<p>KVAROVI I REKLAMACIJE</p> <p>KVAROVE NEMOJTE POPRAVLJATI SAMI ! KVAR ODMAH prijavite na jedno od servisnih mjesta jer u suprotnom može doći do većeg oštećenja aparata, za što proizvođač neće preuzeti odgovornost.</p> <p>Ako do nekog kvara na aparatu dođe tijekom jamstvene dobi, nemojte ga popravljati sami. Reklamaciju ODMAH prijavite na jedno od servisnih mjesta jer u suprotnom može doći do većeg oštećenja aparata, za što proizvođač neće preuzeti odgovornost. Pri podnošenju reklamacije držite se teksta Jamstvenog lista.</p> <p>Najnovije informacije o servisnim mjestima nalaze se na web stranici www.koncar-ka.hr</p> <p>Bez predaje pravilno popunjenog Jamstvenog lista i priloženog računa za kupljeni aparat reklamacija je nevažeća.</p>
---	---

VAŽNA UPOZORENJA ZA SIGURNU UPORABU KUHALA!

NE RABITE APARAT PRIJE NEGO PROČITATE UPUTE ZA UPORABU I UPOZNATE SE S NJEGOVOM UPORABOM.

Zbog Vaše sigurnosti, morate se pridržavati naputaka u ovim uputama te na taj način smanjiti rizike od požara, eksplozija, elekričnog udara, oštećenja imovine, opasnosti po okoliš, ozljedama osoba s ozbiljnim ili tragičnim posljedicama.

Provjerite da li ste aparat primili neoštećen. U Slučaju oštećenja aparata, nastala tijekom transporta prijavite odmah prodavaču.
NE RABITE OŠTEĆENI APARAT.

POZORNOST! Proizvođač/distributer ne preuzima nikakvu odgovornost za oštećenja nastala prilikom uporabe neuzemljenog aparata, te u svezi bilo kakvog oštećenja i povreda ako se ne pridržava uputa za uporabu, u slučaju nesavjesne i nepravilne uporabe aparata, samostalnih popravaka i modifikacija te uporabe dijelova koji nisu originalni i odobreni od proizvođača.

POZORNOST! Po primitku aparata, raspakirajte ga, ambalažni materijal (plastičnu foliju, stiropor, drvo...) uklonite izvan domašaja djece kako se djeca ne bi ozljedila (progutala manje komade ili se ugušila plastičnom folijom).

POZORNOST! Ambalažni materijal (plastična folija, stiropor, drvo...) je opasan za djecu. Djeci nemojte dozvoliti igranje ambalažnim materijalom, kako ne bi progutala manje komade ili se ugušila plastičnom folijom.

POZORNOST! Ovaj aparat mogu upotrebljavati djeca u dobi od osam godina i starija te osobe sa smanjenim tjelesnim, osjetnim ili duševnim sposobnostima ili pomanjkanjem iskustva i znanja ako dobiju nadzor ili uputu o uporabi aparata na siguran način te razumiju uključene opasnosti.

POZORNOST! Ne ostavljajte djecu bez stalnog nadzora u blizini aparata.

POZORNOST! Djeca se ne smiju igrati aparatom, penjati, stajati ili sjediti na istom.

POZORNOST! Čišćenje i korisničko održavanje ne smiju obavljati djeca bez nadzora. Isto vrijedi i za maloljetne osobe.

POZORNOST! Ovaj aparat nije namijenjen osobama (uključujući djecu) koje imaju smanjene fizičke, osjetne ili mentalne sposobnosti, kao i osobama koje nisu dovoljnoiskusne i informirane, osim ako ih se nadgleda ili ako su dobile upute o uporabi aparata od osobe odgovorne za njihovu sigurnost.

POZORNOST! Kućni ljubimci moraju biti pod stalnim nadzorom te im se mora onemogućiti penjanje po aparatu, zavlčenje u isti, kao i griženje kablova. Prije uporabe aparata obavite provjeru!

OPREZ! Ako je uz kuhalo isporučeno strugalom sa staklenom oštricom ili britvicom, tada treba biti posebno oprezan s uporabom jer može doći do povreda i posjekotina. Držati izvan dohvata djece !

POZORNOST! Kuhalo treba nadzirati tijekom njegova rada.

OPASNOST OD EKSPLOZIJE! Nije dozvoljeno zagrijavanje hrane ili tekućina u zatvorenim posudama ili konzervama, zbog širenja sadržaja uzrokovanog zagrijavanjem.

OPASNOST OD POŽARA! Pregrijano ulje ili mast mogu se brzo zapaliti na vrućoj zoni za kuhanje. Zbog toga tijekom pripreme hrane u ulju treba biti oprezan.

OPASNOST OD POŽARA! Nikada ne pokušavajte gasiti požar vodom nego isključite kuhalo te ugasite plamen tako da ga pokrijete poklopcem ili vatrootpornim platnom.

OPASNOST OD POŽARA! Nije dozvoljeno stavljati zapaljive materijale, tekućine čije se pare mogu zapaliti, na ili u blizinu kuhala koje je u uporabi.

OPREZ! Tijekom rada zagrijavaju se pojedini dijelovi aparata, ponajprije mjesta za kuhanje i njihova okolina. Nakon uklanjanja posude s hranom, površina za kuhanje ostaje neko vrijeme vruća. Ne dodirivati površinu jer može doći do opekline. Zbog toga se djeca ne smiju se zadržavati u blizini kuhala.

OPREZ! Ako se na staklokeramičkoj ploči pojave pukotine, prsnuća ili lomovi, nemojte je više rabiti, isključite sve prekidače zona za kuhanje, isključite kuhalo iz utičnice ili izvadite osigurač kako ne bi došlo do strujnog udara i pozovite nadležni servis.

OPREZ! Ne rabite abrazivna sredstva ili oštre metalne predmete kako biste očistili staklokeramičku ploču jer biste tako mogli zagrebat površinu stakla i uzrokovati pucanje i rasipanje stakla.

OPREZ! Staklokeramička ploča je vrlo otporna, ali nije nelomljiva! Posebno šiljasti i tvrdi predmeti koji padnu s visine mogu oštetiti staklokeramičku ploču.

OPREZ! Nije dopušteno staklokeramičku ploču rabiti kao radnu površinu, kao niti odlagati teške predmete na istu.

POZORNOST! Kuhalo može priključiti na električnu instalaciju u skladu s postojećim zakonskim propisima samo ovlaštena i stručno osposobljena osoba. Nestručno priključenje, modifikacije i popravci mogu uzrokovati električni udar i tjelesne ozljede, a za što proizvođač neće preuzeti nikakvu odgovornost.

POZORNOST! Kuhalo obvezatno mora biti uzemljeno! Aparat je predviđen za napon 220-240V~ 50/60 Hz, 16A. Pri priključenju treba voditi računa o tome da električna instalacija do mjesta na kojem se priključuje kuhalo bude takva da izdrži potrebnu struju.

POZORNOST! Kuhalo se ne smije priključivati na vanjski *timer* ili odvojeni daljinski upravljač.

POZORNOST! Ne uključujte aparat prije nego ga instalirate.

POZORNOST! Budite uvjereni kako priključni vod nije oštećen, prignječen ili zapetljan tijekom instalacije. Ne uključujte kuhalo u električnu instalaciju ako je priključni vod oštećen.

POZORNOST! Oštećeni priključni vod mora biti zamijenjen ispravnim, a smije ga zamijeniti jedino stručna osoba ili serviser. Nestručno priključenje i popravci mogu uzrokovati električni udar i tjelesne ozljede.

POZORNOST! Tijekom priključivanja električnih aparata u blizini kuhala mora se voditi računa o tome da njihov priključni kabel ne dođe u dodir s vrućim dijelovima kuhala.

POZORNOST! Nije dozvoljeno uključivati neispravni aparat, nego se isti treba isključiti iz električne mreže (vađenjem utičnice iz utikača ili isključenjem osigurača), a nakon toga je potrebno pozvati ovlaštenu servis.

POZORNOST! Ako dođe do nekog kvara na aparatu, nemojte ga popravljati sami jer u suprotnom može doći do većeg oštećenja aparata, za što proizvođač neće preuzeti odgovornost. Kvarove odstranjuju samo ovlaštenu serviseri.

POZORNOST! Kuhalo treba postaviti samo u zadovoljavajuće prozračnoj prostoriji. Pri intenzivnijoj uporabi kuhala potrebno je jače prozračivanje ili uključivanje nape.

POZORNOST! Kuhalo se ne smije čistiti visokotlačnim parnim aparatom za čišćenje, mlazom ili prskanjem vodom jer može doći do kratkog spoja i oštećenja kuhala.

POZORNOST! Nije dozvoljeno zagrijavanje praznih posuda bez hrane, jer može doći do oštećenja.

POZORNOST! Metalni objekti kao što su pribor za jelo i poklopci, metalne folije, limovi ili krpe ne smiju se stavljati na površinu kuhala jer bi se isti mogli zagrijati ili zapaliti te uzrokovati oštećenja, požar ili opekline.

POZORNOST! Posude za kuhanje uvijek stavljajte na sredinu zone za kuhanje, a držače posuda pomaknite u sigurni položaj kako se za njih ne bi zapelo rukom te prevrnulo.

POZORNOST! Za pridržavanje posuđa i tava rabite krpe ili rukavice kako biste izbjegli opekline.

POZORNOST! Zaštitite aparat od atmosferskih utjecaja (sunce, kiša, snijeg, prašina, vlaga, i sl.).

POZORNOST! Kuhalo ne smije služiti za zagrijavanje prostorija!

POZORNOST! Aparatu najbliže susjedne stjenke, odnosno kuhinjski elementi (tlo, stražnji kuhinjski zid, bočni zidovi) moraju biti otporni na temperaturu od najmanje 100 °C.

NAPOMENA! Ako se kuhalo ne koristi tada se mora isključiti preko odgovarajućeg senzora za uključivanje/isključivanje.

NAPOMENA! Nakon uključivanja zone za kuhanje čuje se zujanje (ponekad i škljocanje) koje nakon nekog vremena prestane. To je zujanje svojstveno zagrijavanju zračenjem i ne djeluje na funkciju mjesta za kuhanje.

NAPOMENA! Ako se kuhalo ne koristi duži vremenski period (godišnji odmor i sl.), isključite ga iz električne mreže (vađenjem utikača iz utičnice ili isključite osigurač).

Ovaj je aparat namijenjen za korištenje u kućanstvima i sličnim okruženjima, kao što su:

- priručne kuhinje za osoblje u trgovinama, uredima i drugim radnim okruženjima;
- korištenje od strane gostiju u hotelima, motelima i drugim smještajnim prostorima;
- gospodarske zgrade i farme
- objekti koji nude usluge noćenja s doručkom.



U uputama za uporabu mogu biti opisani različiti tipovi aparata koji se međusobno razlikuju po opremljenosti i načinu rada, te mogu biti uključena i neka poglavlja koja za Vaš aparat ne dolaze u obzir.

Crteži su samo informativne naravi te ne moraju izgledati kao u stvarnosti.

Tehničke specifikacije proizvoda i ovaj priručnik podložni su promjenama bez prethodne obavijesti ili najave.

Pridržavamo pravo izmjena i grešaka u uputama za uporabu.

Proizvođač zadržava pravo promijeniti konstrukciju, mjere i težinu ako to smatra potrebnim radi poboljšanja kvalitete proizvoda, bez ugrožavanja osnovnih svojstava proizvoda. Tehničke specifikacije proizvoda samo su informativne naravi te su podložni promjenama bez prethodne obavijesti ili najave.

Tehnički podaci	
Model	UK302KM
Broj kuhaćih zona	2
Napon / Frekvencija	220-240V~ 50/60Hz
Nazvina snaga (W)	2700-3300W
Dimenzije kuhala (mm)	288X520X55
Ugradbena dimenzija (mm)	268X490

Informacijski list / Informacija o proizvodu	
Zaštitni znak dobavljača	KONČAR
Model	UK302KM
Vrsta kuhala	električno ugradbeno
Broj kuhaćih zona	2
Tehnologija zagrijavanja 1	radijantna kuhaća zona
Veličina 1	promjer 16,5 cm
Potrošnja energije 1 po zoni za kuhanje ili području po kg	183.8 Wh/kg
Tehnologija zagrijavanja 2	radijantna kuhaća zona
Veličina 2	promjer 20 cm
Potrošnja energije 2 po zoni za kuhanje ili području po kg	188.9 Wh/kg
Ukupna potrošnja energije po kg za električno kuhalo	186.4 Wh/kg
Kuhalo zadovoljava EN 60350-2:2013	

SKICA I OPIS APARATA

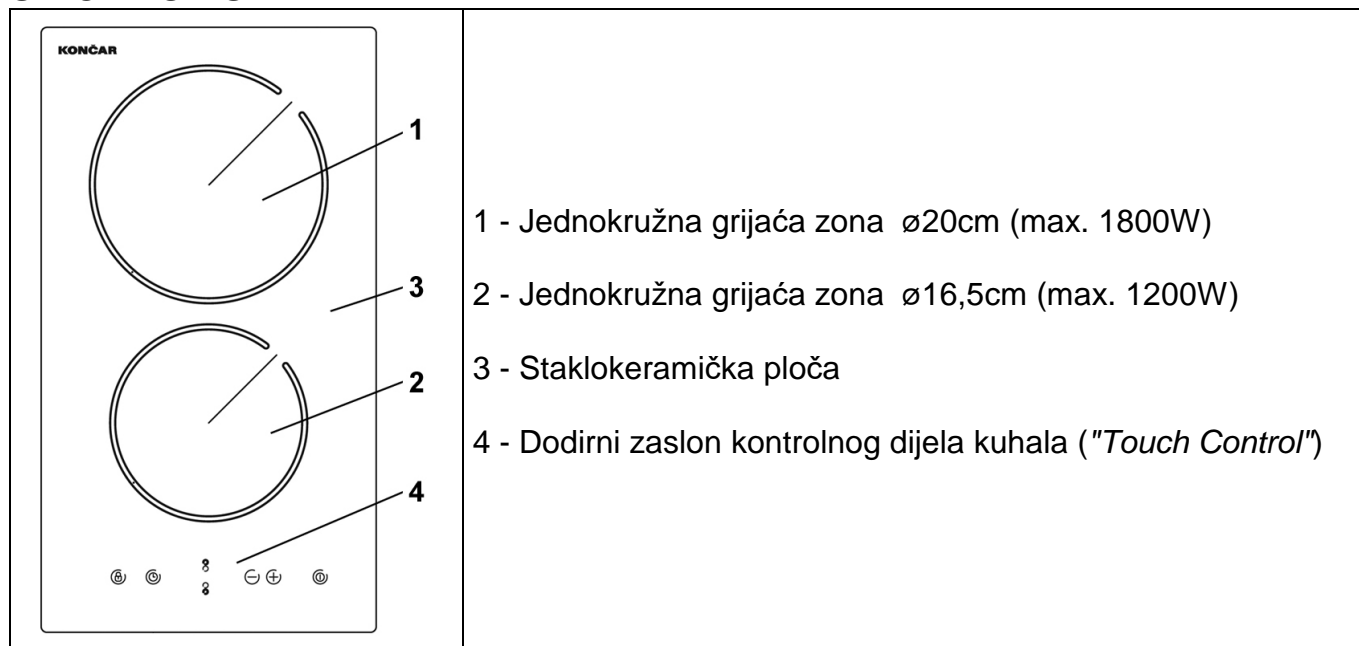

UPRAVLJAČKI ELEMENTI (SENZORI)

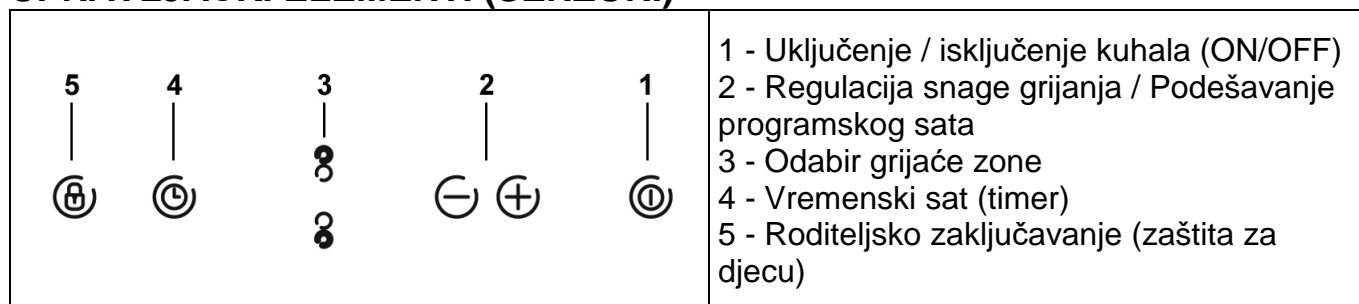

Ova staklokeramička kuhala su opremljena elektronskim dodirnim zaslonom, kojima se upravlja dodiranjem prsta na osjetilo - označeno mjesto ("Touch control"). Kontrole reagiraju na dodir, pa nije potreban nikakav pritisak. Dodir je potvrđen i zvučnim signalom.

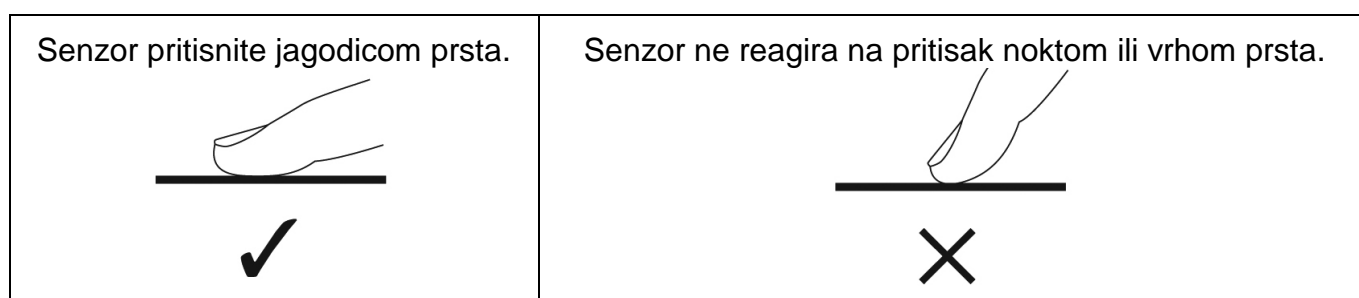

NAPOMENA! Ne stavljajte nikakve predmete (pribor za jelo, krpe i sl.) na dodirni zaslon i uvijek ga održavajte suhim (čak i tanak sloj tekućine može onemogućiti kontrolu) i čistim.

ODABIR PRIKLADNOG POSUĐA ZA KUHANJE

NAPOMENA! Nikada ne uključujte zonu bez posude sa hranom.

Za kuhanje koristite samo posuđe s ravnim i masivnim dnom, koje ne mijenja oblik ni pri visokim temperaturama.

Posuđe s hrapavim ili deformiranim dnom nije preporučljivo stavljati na staklokeramičku ploču jer je može izgrebati ili loše nalijegati na istu.

Izaberite uvijek odgovarajuću zonu za kuhanje prema posudi: dno posude i promjer zone trebaju biti podjednako veliki. Ukoliko je posuda premalena dolazi do gubitka topline, a ploča se može oštetiti.

Pazite kod postavljanja posude da posuda bude u sredini zone za kuhanje.

Posuda se, sa zone za kuhanje, uvijek podiže prema gore, a ne ju povlačiti po površini ploče jer se ploča može izgrebati.

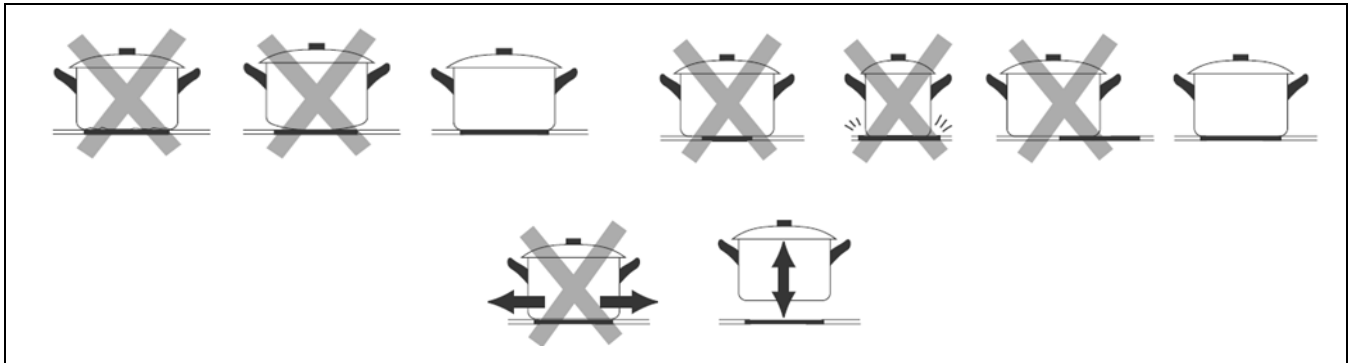

Staklokeramička ploča i dno posude moraju uvijek biti čisti: prljavština i ostaci hrane (posebno oni koji sadrže šećer) te zrnca pijeska ili ostaci sredstava za čišćenje mogu se zapeći na ploči i oštetiti je.

Prije stavljanja posude na mjesto za kuhanje, treba dobro obrisati dno posude da bi se omogućilo dobro provođenje topline. Dno posude ne smije biti vlažno.

Kuhajte uvijek u poklopljenom posuđu i pri tome pazite da poklopac dobro naliježe.

Kada jelo zakuha, smanjite temperaturu. Izbjegavajte prelijevanje tekućina na radnu ploču.

Uvijek pazite da u posudama uvijek bude dovoljno tekućine jer, zbog isparavanja, posuda može ostati prazna, a zbog pregrijavanja može doći do oštećenja posude i grijaće zone.

NAPOMENA! Nakon uporabe potrebno je isključiti kuhalo preko kontrolnog panela.

UPORABA KUHALA



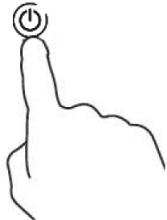
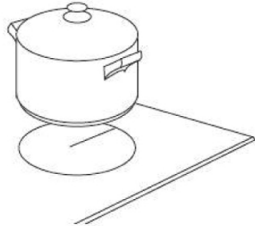

Nakon što se kuhalo priključi na električnu mrežu, svi se pokazivači uključe na kratko vrijeme. Nakon toga, kuhalo je u stanju pripravnosti te je spremno za uporabu.

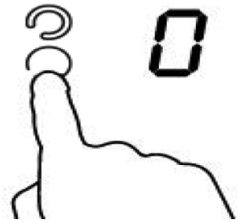
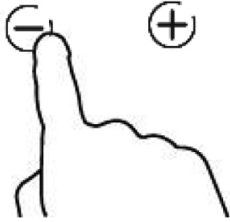
POČETAK KUHANJA

<p>Kuhalo se uključuje pritiskom na senzor za uključenje / isključenje kuhala. Oglašava se zvučni signal. Indikatori ispisuju vrijednost "-".</p>	
<p>Postavite odgovarajuću posudu (napunjenu hranom) na željenu zonu za kuhanje. Prije stavljanja posude na mjesto za kuhanje, treba dobro obrisati dno posude i zonu za kuhanje.</p>	



<p>Pritisnite senzor za odabir zone za kuhanje.</p>	
<p>Temperaturu (snagu grijanja) odabrane grijaće zone povećavate pritiskom na senzor "+", a smanjujete pritiskom na senzor "-". Ukoliko u roku od 1 minute ne aktivirate rad niti jedne grijaće zone, kuhalo se automatski isključuje. Promjena temperature moguća je u svakom trenutku kuhanja. Ako se senzor drži pritisnutim, vrijednosti će se same povećavati ili smanjivati.</p>	

ZAVRŠETAK KUHANJA

<p>Pritisnite senzor za odabir zone za kuhanje, a koju želite isključiti.</p>	
<p>Pomoću senzora "-" smanjite temperaturu na "0" ili istovremeno pritisnite senzore "+" i "-".</p>	
<p>Kuhalo se isključuje pritiskom na senzor za uključenje / isključenje kuhala.</p>	
<p>POZORNOST! Opasnost od opekline!</p> <p>Preostala temperature rada (zaostala toplina) Po završetku pripreme hrane, staklokeramička ploča zadržava određenu temperaturu koja se naziva zaostala toplina, a može biti opasna jer može uzrokovati opekline. Nakon isključenja grijaće zone, ukoliko je temperatura visoka, biti će prikazan simbol "H". Simbol ostaje prikazan sve dok vrijednost temperature ne padne na sigurnu razinu.</p>	

RODITELJSKO ZAKLJUČAVANJE (ZAŠTITA ZA DJECU)

Ovom funkcijom možete zaključati (onemogućiti uporabu) senzore na kontrolnom zaslonu čime onemogućujete neželjeno korištenje (npr. kako djeca ne bi uključila zone za kuhanje).

Za aktivaciju zaključavanja pritisnuti senzor . Kao potvrda uključanja funkcije, biti će prikazan simbol "L". U slučaju da je ova funkcija aktivirana, moguće je jedino koristiti senzor za uključanje / isključenje .

Kako bi se funkcija isključila, kuhalo mora biti uključeno. Nakon toga je potrebno pritisnuti i kratko držati senzor .



Kuhalo će ostati zaključano čak i ako se isključi ili uključi. Kada je kuhalo je u potpunosti zaključano, dostupan je jedino senzor za uključanje / isključenje , kojim uvijek možete uključiti kuhalo, ali prije svih drugih operacija morate isključiti funkciju zaključavanja.

VREMENSKI SAT (TIMER)

Vremenski sat se može koristiti na dva načina.

1. Brojač minuta. U tom slučaju, timer neće isključiti nijednu zonu kad postavljeno vrijeme istekne.
2. Isključenje jednog ili više zona za kuhanje kad postavljeno vrijeme istekne. Maksimalno vrijeme je 99 minuta.

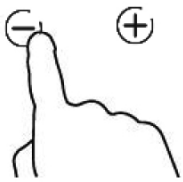
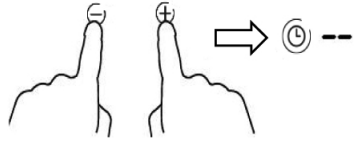
1. Brojač minuta, ako nije odabrana niti jedna zona za kuhanje.



<p>Kuhalo mora biti uključeno. Napomena: Brojač minuta se može koristiti ako nije odabrana niti jedna zona za kuhanje. Kad pritisnete senzor vremenskog sata, na indikatoru timera treperi ; Podesite vrijeme pritiskom na senzore "-" ili "+". Indikator brojača minuta će početi treperiti i prikazati podešeno vrijeme na displayu.</p>	
<p>Ako istovremeno pritisnete "-" i "+", timer se poništava, a na displayu se prikazuje "--".</p>	
<p>Kada je vrijeme postavljeno, odmah počinje odbrojavanje. Na displayu će se prikazati preostalo vrijeme i indikator timera treperiti će 5 sekundi.</p>	
<p>Oglasiti će se zvučni signal u trajanju od 30 sekundi, a indikator timera pokazuje "--" kad podešeno vrijeme istekne.</p>	

Napomene:

Pritisnuti jednom senzor "-" ili "+" pa će se vrijeme smanjivati ili povećavati po 1 minutu.
 Pritisnuti i zadržati senzor "-" ili "+" pa će se vrijeme smanjivati ili povećavati po 10 minuta.
 Ako vrijeme podešavanja prijeđe 99 minuta, vrijeme će se automatski vratiti na 0 minuta.

2. Postavljanje vremenskog sata da isključi jednu ili više zona za kuhanje.

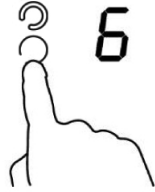
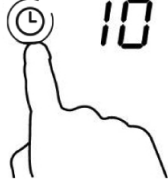
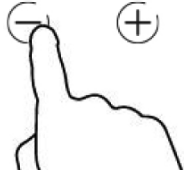
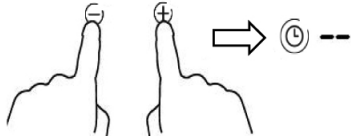
Podešavanje za jednu zonu:

Pritisnete senzor zone koju želite koristiti.	
Pritisnete senzor vremenskog sata. Na displayu će se prikazati "10".	
Podesite vrijeme pritiskom na senzor "-" ili "+" .	
Ako istovremeno pritisnete "-" i "+", timer se poništava, a na displayu se prikazuje "--".	
Kad je vrijeme postavljeno, odmah počinje odbrojavanje. Na displayu će se prikazati preostalo vrijeme i indikator timera treperit će 5 sekundi.	
Kad istekne vrijeme kuhanja, podešena zona za kuhanje automatski će se isključiti. Na displayu će se prikazati "H" što znači da je zona vruća.	

Napomene:

Crvena točkica pokraj indikatora razine snage   označit će da je zona za kuhanje odabrana.

Ako želite promijeniti vrijeme nakon podešavanja timera, morat ćete početi od početka. Postupak podešavanja za dvije zone potpuno je jednak kao i postupak za jednu zonu..

Postavljanje vremenskog sata da isključi više od jedne zone za kuhanje.

A) Ako više od jedne zone za kuhanje koristi ovu funkciju, timer će prikazivati najkraće vrijeme. Npr., ako je za zonu 1 podešeno vrijeme od 5 minuta, a za zonu 2 od 15 minuta, timer će prikazivati "5".

NAPOMENA: Crvena točkica pokraj indikatora razine snage će treperiti.



B) Kad vrijeme odbrojavanja istekne, odgovarajuća zona za kuhanje će se isključiti. Zatim će se prikazati novi brojač minuta i točka odgovarajuće zone za kuhanje će treperiti.

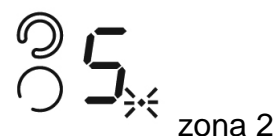
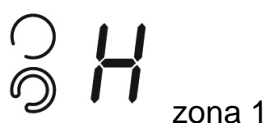

C) Kad istekne vrijeme kuhanja, odgovarajuća zona za kuhanje automatski će se isključiti.



Napomena:

1) Crvena točkica pokraj indikatora razine snage označit će da je zona za kuhanje odabrana.



2) Ako želite promijeniti vrijeme nakon podešavanja timera, morat ćete početi od početka.

ZAŠTITNI ELEMENTI UGRAĐENI U KUHALO

Zaštita od previsoke temperature

Ugrađeni temperaturni senzor mjeri temperaturu staklokeramičke ploče. U slučaju da je izmjerena previsoka temperatura, kuhalo automatski prestaje s radom.

Upozorenje na preostalu toplinu

Ako je kuhalo bilo u uporabi neko vrijeme, preostat će topline i nakon isključenja. Na displayu se prikazuje slovo "H" kako bi vas upozorilo da pripazite na vruće površine.

Ograničenje vremena rada kuhaće zone

Automatsko isključivanje je još jedna od sigurnosnih značajki kuhala. To se događa u slučaju da zaboravite isključiti zonu za kuhanje. Zadana vremena isključenja prikazana su u tablici:

Razina snage	1	2	3	4	5	6	7	8	9
Maksimalno dozvoljeno vrijeme rada (sati)	8	8	8	4	4	4	2	2	2

UPUTE I SAVJETI ZA UPORABU KUHALA

	<p>POZOR! OPASNOST OD OPEKLINA! Tijekom rada zagrijavaju se pojedini dijelovi kuhala, ponajprije mjesta za kuhanje i njihova okolina. Visoka temperatura može biti visoka i nakon kuhanja.</p> <p>OPASNOST OD POŽARA! Nikada ne ostavljajte predmete na površini za kuhanje! Priprema hrane u ulju ili na masti zahtijeva oprez jer se pregrijano ulje ili mast mogu brzo zapaliti i uzrokovati požar. NIKADA ne pokušavajte gasiti požar vodom nego isključite kuhalo te ugascite plamen tako da ga pokrijete poklopcem ili vatrootpornim platnom.</p>
---	--

Napomena: Savjeti daju primjere kako hranu treba pripremati i imaju ulogu samo općeg vodiča jer svatko kuha prema vlastitim navikama i iskustvima.

Kad jelo proključa, snizite temperaturu kuhanja.

Korištenje poklopcu skratit će vrijeme kuhanja i šteti energiju zadržavanjem topline.

Minimizirajte količinu tekućine ili masnoće kako biste skratili vrijeme kuhanja.

Započnite kuhati na visokim temperaturama i smanjite ih kad se hrana zagrije.

Pirjanje se odvija ispod točke vrenja, na oko 85 °C, kad mjehurići tek povremeno izbijaju na površinu. Ključ je za ukusne juhe i blage gulaše jer se okusi razvijaju bez prekuhanja hrane. I umake na bazi jaja i brašna također kuhate ispod točke vrenja.

Neki zadaci, poput kuhanja riže apsorpcijskom metodom, mogu zahtijevati postavljanje više temperature od najniže vrijednosti kako bi se jelo skuhalo u preporučenom vremenu.

Za pripremu sočnog odreska:

1. Neka meso odstoji na kućnoj temperaturi oko 20 minuta prije kuhanja.
2. Zagrijte tavu s teškom osnovom.
3. Obje strane odreska premažite uljem. U vruću tavu ulijte malo ulja, a zatim spustite meso na vruću tavu.
4. Odrezak okrenite samo jednom tijekom kuhanja. Vrijeme kuhanja ovisi o debljini odreska i načinu na koji ga želite skuhati. Vrijeme može varirati 2 - 8 minuta po strani odreska. Pritisnite odrezak kako biste utvrdili koliko je kuhan - što se čvršće osjeća to je "jače pečen".
5. Ostavite odrezak nekoliko minuta na tanjuru kako bi se opustio i omekšao prije serviranja.

Prženje:

1. Izaberite wok ravnog dna ili veliku tavu prikladnu za kuhanje na staklokeramičkoj ploči.
2. Pripremite sve potrebne sastojke i pribor. Prženje miješanjem treba biti brzo. Ako kuhate veće količine, kuhajte hranu u nekoliko manjih posuda.
3. Dobro zagrijte tavu i dodajte dvije žlice ulja.
4. Prvo skuhanje meso, stavite sa strane i održavajte mu toplinu.
5. Prženje povrća Dok je povrće vruće, ali još uvijek hrskavo, snizite temperaturu polja za kuhanje, vratite meso u tavu i dodajte umak.
6. Nježno miješajte sastojke kako biste bili sigurni da su posve zagrijani.
7. Odmah poslužite.

Upravljanje kuhaćim zonama - postavke na displayu.

Odaberite odgovarajuću temperaturu ovisno o vrsti jela. U tablici se nalaze samo orijentacijske vrijednosti kao vodič.

Postavka	Uporaba
1 - 2	blago zagrijavanje malih količina hrane , topljenje čokolade, maslaca i hrane koja brzo izagara, blago pirjanje, sporo zagrijavanje
3 - 4	podgrijavanje, brzo pirjanje, kuhanje riže
5 - 6	palačinke
7 - 8	kuhanje, kuhanje tjestenine
9	prženje miješanjem, prženje, vrenje juhe, prokuhavanje vode

ČIŠĆENJE I ODRŽAVANJE

	<p>Prije čišćenja kuhala pričekajte da se kuhalo ohladi na sigurnu temperaturu. Obvezatno isključite kuhalo iz električne instalacije: izvadite osigurač ili isključite LS-automat ili izvadite utikač iz utičnice. Kuhalo se ne smije čistiti visokotlačnim parnim aparatom za čišćenje jer može doći do kratkog spoja i oštećenja kuhala.</p>
---	--

Ako je kuhalo još uvijek zagrijano (treperi simbol "**H**") i ako želimo izbjeći opekline, tada je potrebno je pričekati da se kuhalo ohladi. Ako je kuhalo isključeno s električne mreže, neće biti indikatora "vruće površine", ali zona za kuhanje još uvijek može biti vruća ! Budite jako oprezni.

Čistite staklokeramičku ploču uvijek kada je malo prljava - najbolje poslije svake uporabe jer se inače kod svake sljedeće uporabe i najmanja nečistoća zapeče na vruću površinu . Za to koristite vlažnu krpu s malo deterdženta za ručno pranje posuđa. Nakon toga osušite je čistom krpom ili papirnatim ručnikom. Ne smije biti ostataka ostatke čišćenja i deterdženta na površini. Prašinu sa površine treba čistiti vlažnom krpom.

Ne rabite abrazivna sredstva ili oštre metalne četke ili žice za čišćenje jer mogu oštetiti staklo i uzrokovati njegov lom.

Zagorjeli šećer ili rastopljenu plastičnu masu odstraniti odmah, dok je vruće, staklenim strugalom ili britvicom, a zatim očistiti deterdžentom. Uklonite s površine zrnca pijeska ili sl. koja bi mogla oštetiti staklokeramičku ploču.

Mrlje od kamenca i sjajne sedefaste mrlje nastale tijekom kuhanja odstraniti strugalom sa staklenom oštricom ili britvicom i ponoviti postupak s deterdžentom.

Ako dođe do proljevanja tekućine preko senzora za kontrolu tada se mogu javiti zvučni signali, a senzori neće reagirati jer je na njima tekućina. Potrebno je isključiti kuhalo s električne mreže, upiti i obrisati prelivenu tekućinu, obrisati područje senzora čistom spužvom ili krpom, te ih potpuno posušiti suhom krpom ili papirnatim ručnikom, ponovno uključiti kuhalo na električnu mrežu.

Tijekom vremena može doći do promjene boje staklokeramičke ploče, što je normalna pojava, te ne utječe na strukturu ili otpornost materijala. **Promjena boje ploče nije predmet reklamacije.**

Razlozi u promjeni boje mogu biti nečišćenje prolivene hrane, uporaba neadekvatnog posuđa za kuhanje koje erodiraju površinu, ili neadekvatnog sredstva za čišćenje.

MOGUĆI PROBLEMI I NJIHOVO RJEŠAVANJE

Ukoliko Vaš aparat ne radi ispravno, uzrok bi mogla biti neka sitnica. Kako biste uštedijeli vrijeme i novac prije pozivanja servisera, provjerite sljedeće:

Problem	Mogući uzrok	Moguće rješenje
Upravljački dio kuhala ne svjetli. Kuhalo se ne može uključiti.	Nema dotoka električne energije.	Provjerite da li je kuhalo priključeno na električnu instalaciju. Provjerite da li ostali aparati također rade. Pregorio je osigurač. Provjerite je li osigurač odgovarajući. Ako se problem ponavlja, pozovite servis.
Senzori ne reagiraju.	Uključeno je roditeljsko zaključavanje (zaštita za djecu).	Isključiti roditeljsko zaključavanje.
Senzorima se teško upravlja.	Možda se na senzorima stvorio tanak sloj vlage. Mokri senzori. Senzori su prekriveni predmetom ili ih pokušavate regulirati vrhom prsta.	Budite sigurni da je područje dodirnih senzora suho, da nisu prekriveni predmetima i pri dodiru koristite jagodicu prsta.
Staklo je izgrebeno.	Posuđe s grubim rubovima. Upotrebljavaju se neprikladna sredstva ili abrazivni proizvodi za čišćenje.	Pogledajte "Odabir prikladnog posuđa za kuhanje". Pogledajte "Čišćenje i održavanje".
Neke posude pucketaju ili se čuju drugi zvukovi.	Uzrok može biti konstrukcija vašeg posuđa (slojevi različitih metala različito vibriraju).	To je uobičajena pojava.
Kuhalo se isključuje tijekom uporabe	Jedna od kuhaćih zona predugo je uključena.	Zona se može ponovno koristiti nakon što se kuhalo uključi.

UPUTE ZA POSTAVLJANJE I PRIKLJUČENJE

	<p>Postavljanje i priključak kuhala može obaviti jedino ovlaštena i stručno osposobljena osoba, a u skladnosti s trenutnim državnim zakonima, normama, direktivama, te ostalim regulativama.</p> <p>Nepropisna i nestručna instalacija može biti opasna te uzrokovati povrede i oštećenja. Proizvođač/distributor u tom slučaju ne preuzima odgovornost, a jamstvo ne vrijedi.</p> <p>Nije dozvoljena uporaba aparata ako nije propisno postavljen i priključen.</p>
---	---

POSTAVLJANJE KUHALA

Kuhalo se može postaviti samo u zadovoljavajuće prozračnim prostorijama! Pri tome treba paziti da budu zadovoljeni propisi o veličini i provjetranju prostorije tj. izmjeni zraka (prirodnim putem, pomoću ventilatora za izmjenu zraka ili pomoću kuhinjske nape).

Pogledajte da li kuhalo ima ikakvih oštećenja nastalih u transportu. Pažljivo rukujte prilikom postavljanja. Budite oprezni - rubovi ploče su oštri. Nepridržavanje ovih uputa može rezultirati ozljedom.

	<p>Ne instalirati blizu zapaljivih dijelova namještaja (npr. zavjesa). Ne postavljati na aparate za hlađenje, perilice posuđa ili sušilice rublja.</p> <p>Aparatu najbliže susjedne stjenke, odnosno kuhinjski elementi (tlo, stražnji kuhinjski zid, bočni zidovi) moraju biti otporni na temperaturu od najmanje 100 °C.</p> <p>Radna ploča na koju se ugrađuje kuhalo mora biti otporna na temperature veće od 100 °C te minimalne debljine 30mm.</p> <p>Ljepilo koje spaja plastiku ili drvene materijale mora imati otpornost na temperature ne veće od 150°C, kako biste izbjegli odvajanje oplate.</p>
---	---

1. Izrežite radnu površinu prema mjerama prikazanim na crtežu.

Za potrebe ugradnje i uporabe oko otvora ostavite najmanje 5 cm prostora.

Budite sigurni da je radna površina debela najmanje 30 mm. Molimo odaberite izoliranu radnu površinu od materijala otpornog na toplinu (drvo i slični vlaknasti ili higroskopni materijali ne smiju se koristiti kao radna površina osim ako su impregnirani) kako biste izbjegli opasnost od strujnog udara i veća oštećenja uzrokovana toplinskim zračenjem zona za kuhanje.

Slijedite korake u nastavku:

Napomena: Sigurna udaljenost između unutrašnjih stranica kuhala i unutarnje površine radne ploče mora biti najmanje 3 mm.

	A	268 - 272 mm
	B	490 - 494 mm
	C	min. 50mm
	D	min. 50mm
	E	min. 50mm
	F	min. 50mm
	G	min. 3mm

2. Staklokeramičko kuhalo može se ugraditi na gornju plohu kuhinjskog elementa.

Ploču treba postaviti vodoravno.

	A	min. 50mm
	B	min. 50mm

Staklokeramička ploča za kuhanje mora imati osiguranu dobru ventilaciju te da ulaz i izlaz zraka nisu blokirani. Okomiti razmak između kuhala i nape mora biti najmanje onakav kakav je naznačen u uputama za postavljanje nape, a ako nape nema, razmak do gornjeg kuhinjskog elementa ili ormarića mora biti min. 76cm.

	A	760 mm
	B	min. 50mm
	C	min. 20mm
	D	Ulaz zraka
	E	Izlaz zraka 5mm



POZORNOST! Kuhalo mora imati osiguranu odgovarajuću ventilaciju !

Ventilacijski otvori nalaze se na vanjskoj strani kućišta kuhala.
MORATE osigurati da ti otvori nisu blokirani kada ugradbeno kuhalo postavite na radnu površinu.

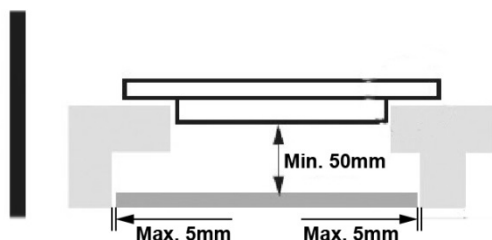

Budite sigurni da staklokeramička ploča za kuhanje ima dobru ventilaciju te da ulaz i izlaz zraka nisu blokirani. Kako bi se izbjeglo slučajno dodirivanje pregrijanog dna ploče ili neočekivanog strujnog udara tijekom rada, potrebno je staviti drveni umetak, pričvršćen vijcima, na minimalnoj udaljenosti od 50 mm od dna ploče za kuhanje.

Nakon izrezivanja otvora i pripreme, očistite element te pripremite kuhalo.

Brtvu postavite po unutarnjem obodu radne ploče. Ne rastežite brtvu.

Očistite površinu radnog površinu od nečistoća, stavite staklokeramičku ploču u otvor i čvrsto pritisnite na radnu površinu.

Pažljivo odstranite višak brtve ako je izašao između kuhala i radne ploče. Kuhalo mora stajati vodoravno.

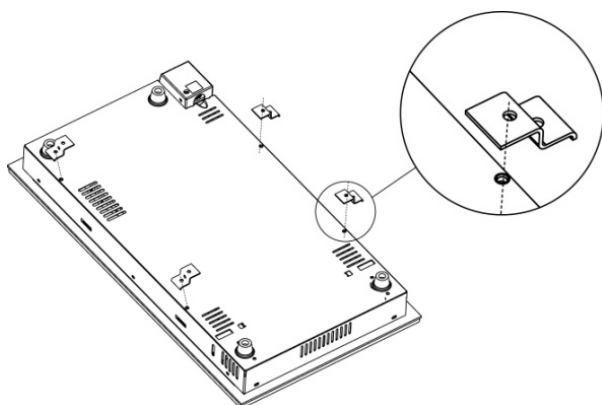

Pritegnite četiri stezača pomoću vijaka na donju stranu kućišta staklokeramičkog kuhala. Podesite položaj stezača prema različitoj debljini radne površine.

Ne pritežite prejako kako ne bi došlo do deformacija kućišta što može uzrokovati neispravnost aparata. U takvom slučaju proizvođač otklanja svaku odgovornost za neispravan rad aparata i posljedice koje takve deformacije mogu prouzročiti.

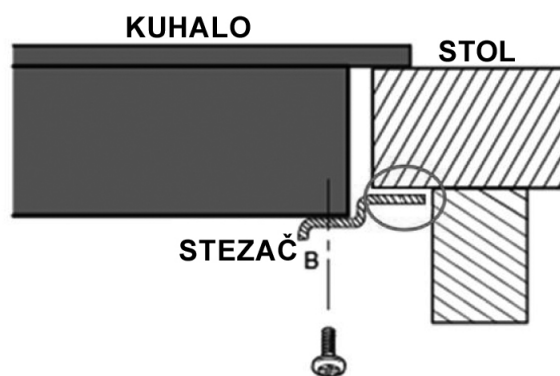
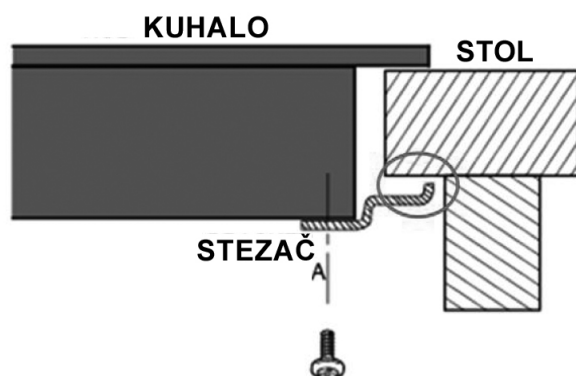

POZORNOST! Ni pod kojim uvjetima, nosači nakon postavljanja ne smiju dodirivati unutarnje dijelove radne površine (pogledajte sliku).

PRIKLJUČAK KUHALA NA ELEKTRIČNU INSTALACIJU

	<p>POZOR! Priključak kuhala na električnu instalaciju može obaviti jedino ovlaštena i stručno osposobljena osoba.</p>
	<p>POZOR! Kuhalo obvezatno mora biti uzemljeno! Električna sigurnost kuhala zajamčena je jedino ako je ono ispravno spojeno na ispravnu električnu instalaciju s uzemljenjem.</p>
	<p>Tijekom priključenja treba voditi računa da električna instalacija do mjesta gdje se priključuje kuhalo bude takva da izdrži potrebnu struju.</p>
	<p>Nepropisna i nestručna instalacija može biti opasna te uzrokovati povrede i oštećenja. Proizvođač/distributor u tom slučaju ne preuzima odgovornost, a jamstvo ne vrijedi.</p>
<p>Nije dozvoljena uporaba aparata ako nije propisno postavljen i priključen.</p>	

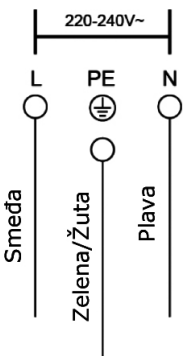
	<p>Kuhalo je tvornički priređeno za priključak na jednofaznu električnu instalaciju 230 V ~.</p> <p>Kuhalo se priključuje na propisno instaliranu zidnu priključnicu s kontaktom za uzemljenje s vlastitim strujnim krugom i osiguračem od 16 A.</p> <p>Fazni vodič L obično je crne ili smeđe boje. Neutralni vodič N (nula) obično je plave boje. Zaštitni vodič PE (uzemljenje) je žuto-zelene boje.</p>
---	---

Električni priključak mora biti trajan (a ne pomoću utikača i utičnice), preko sklopki za odvajanje svih polova od čvrste električne instalacije prema nacionalnim propisima za izradu električne instalacije odgovarajućeg napona.

Zidna priključnica mora biti lako pristupačna (zbog propisa o mogućnosti odvajanja svih polova s električne instalacije) i ne smije biti izložena toplinskom zračenju.

Priključni vod treba biti udaljen od izvora topline i ne smije se zagrijavati (zbog električnog opterećenja).

POZORNOST! Budite uvjereni kako priključni vod nije oštećen, prignječen ili zapetljan tijekom instalacije. Ne uključujte kuhalo u električnu instalaciju ako je priključni vod oštećen.

POZORNOST! Oštećeni priključni vod mora biti zamijenjen ispravnim, a smije ga zamijeniti jedino stručna osoba ili serviser. Nestručno priključenje i popravci mogu uzrokovati električni udar i tjelesne ozljede.

NAPOMENA ! Donja površina i priključni vod kuhala nisu dostupni nakon ugradnje.

Ceramic Hob

Instruction Manual / Installation Manual

Content

1. Foreword	4
1.1 Safety Warnings	4
1.2 Installation	4
1.2.1 Electrical Shock Hazard	4
1.2.2 Cut Hazard	4
1.2.3 Important safety instructions	4
1.3 Operation and maintenance	5
1.3.1 Electrical Shock Hazard	5
1.3.2 Health Hazard	6
1.3.3 Hot Surface Hazard	6
1.3.4 Cut Hazard	6
1.3.5 Important safety instructions	6
2. Product Introduction	8
2.1 Top View	8
2.2 Control Panel	8
2.3 Product Information	8
2.4 Working Principle	9
2.5 Before using your New Ceramic Hob	9
2.6 Technical Specification	9
3. Operation of Product	9
3.1 Touch Controls	9
3.2 Choosing the right Cookware	9
3.3 How to use	10
3.3.1 Start cooking	10
3.3.2 Finish cooking	11
3.3.3 Locking the Controls	11
3.3.4 Timer control	12
3.3.5 Over-Temperature Protection	14
3.3.6 Residual Heat Warning	14
3.3.7 Default working times	14
4. Cooking Guidelines	14
4.1 Cooking Tips	15
4.1.1 Simmering, cooking rice	15
4.1.2 Searing steak	15
4.1.3 For stir-frying	15
5. Heat Settings	15
6. Care and Cleaning	16
7. Hints and Tips	17
8. Installation	17
8.1 Selection of installation equipment	17
8.2 Before locating the fixing brackets	19
8.3 Cautions	20
8.4 Connecting the hob to the mains power supply	20

1. Foreword

1.1 Safety Warnings

Your safety is important to us. Please read this information before using your cooktop.

1.2 Installation

1.2.1 Electrical Shock Hazard

- Disconnect the appliance from the mains electricity supply before carrying out any work or maintenance on it.
- Connection to a good earth wiring system is essential and mandatory.
- Alterations to the domestic wiring system must only be made by a qualified electrician.
- Failure to follow this advice may result in electrical shock or death.

1.2.2 Cut Hazard

- Take care - panel edges are sharp.
- Failure to use caution could result in injury or cuts.

1.2.3 Important safety instructions

- Read these instructions carefully before installing or using this appliance.
- No combustible material or products should be placed on this appliance at any time.
- Please make this information available to the person responsible for installing the appliance as it could reduce your installation costs.
- In order to avoid a hazard, this appliance must be installed according to these instructions for installation.
- This appliance is to be properly installed and earthed only by a suitably qualified person.
- This appliance should be connected to a circuit which incorporates an isolating switch providing full disconnection from the power supply.
- Failure to install the appliance correctly could invalidate any warranty or liability claims.

- This appliance can be used by children aged from 8 years and above and persons with reduced physical, sensory or mental capabilities or lack of experience and knowledge if they have been given supervision or instruction concerning use of the appliance in a safe way and understand the hazards involved.
- Children shall not play with the appliance. Cleaning and user maintenance shall not be made by children without supervision.
- If the supply cord is damaged, it must be replaced by the manufacturer, its service agent or similarly qualified persons in order to avoid a hazard.
- Warning: If the surface is cracked, switch off the appliance to avoid the possibility of electric shock, for hob surfaces of glass-ceramic or similar material which protect live parts
- Metallic objects such as knives, forks, spoons and lids should not be placed on the hob surface since they can get hot
- A steam cleaner is not to be used.
- Do not use a steam cleaner to clean your cooktop.
- The appliance is not intended to be operated by means of an external timer or separate remote-control system.
- WARNING: Danger of fire: do not store items on the cooking surfaces.
- The cooking process has to be supervised. A short term cooking process has to be supervised continuously.
- WARNING: Unattended cooking on a hob with fat or oil can be dangerous and may result in fire. NEVER try to extinguish a fire with water, but switch off the appliance and then cover flame e.g. with a lid or a fire blanket.

1.3 Operation and maintenance

1.3.1 Electrical Shock Hazard

- Do not cook on a broken or cracked cooktop. If the cooktop surface should break or crack, switch the appliance off immediately at the mains power supply (wall switch) and contact a qualified technician.
- Switch the cooktop off at the wall before cleaning or maintenance.
- Failure to follow this advice may result in electrical shock or death.

1.3.2 Health Hazard

- This appliance complies with electromagnetic safety standards.
- However, persons with cardiac pacemakers or other electrical implants (such as insulin pumps) must consult with their doctor or implant manufacturer before using this appliance to make sure that their implants will not be affected by the electromagnetic field.
- Failure to follow this advice may result in death.

1.3.3 Hot Surface Hazard

- During use, accessible parts of this appliance will become hot enough to cause burns.
- Do not let your body, clothing or any item other than suitable cookware contact the Induction glass until the surface is cool.
- Keep children away.
- Handles of saucepans may be hot to touch. Check saucepan handles do not overhang other cooking zones that are on. Keep handles out of reach of children.
- Failure to follow this advice could result in burns and scalds.

1.3.4 Cut Hazard

- The razor-sharp blade of a cooktop scraper is exposed when the safety cover is retracted. Use with extreme care and always store safely and out of reach of children.
- Failure to use caution could result in injury or cuts.

1.3.5 Important safety instructions

- Never leave the appliance unattended when in use. Boilover causes smoking and greasy spillovers that may ignite.
- Never use your appliance as a work or storage surface.
- Never leave any objects or utensils on the appliance.
- Do not place or leave any magnetisable objects (e.g. credit cards, memory cards) or electronic devices (e.g. computers, MP3 players) near the appliance, as they may be affected by its electromagnetic field.
- Never use your appliance for warming or heating the room.
- After use, always turn off the cooking zones and the cooktop as described in this manual (i.e. by using the touch controls). Do not rely on the pan detection feature to turn off the cooking zones when you remove the pans.
- Do not allow children to play with the appliance or sit, stand, or climb on it.

- Do not store items of interest to children in cabinets above the appliance. Children climbing on the cooktop could be seriously injured.
- Do not leave children alone or unattended in the area where the appliance is in use.
- Children or persons with a disability which limits their ability to use the appliance should have a responsible and competent person to instruct them in its use. The instructor should be satisfied that they can use the appliance without danger to themselves or their surroundings.
- Do not repair or replace any part of the appliance unless specifically recommended in the manual. All other servicing should be done by a qualified technician.
- Do not place or drop heavy objects on your cooktop.
- Do not stand on your cooktop.
- Do not use pans with jagged edges or drag pans across the Induction glass surface as this can scratch the glass.
- Do not use scourers or any other harsh abrasive cleaning agents to clean your cooktop, as these can scratch the Induction glass.
- This appliance is intended to be used in household and similar applications such as: -staff kitchen areas in shops, offices and other working environments; -farm houses; -by clients in hotels, motels and other residential type environments; -bed and breakfast type environments.
- **WARNING:** The appliance and its accessible parts become hot during use.
- Care should be taken to avoid touching heating elements.
- Children less than 8 years of age shall be kept away unless continuously supervised.

Congratulations on the purchase of your new Ceramic Hob.

We recommend that you spend some time to read this Instruction / Installation Manual in order to fully understand how to install correctly and operate it. For installation, please read the installation section.

Read all the safety instructions carefully before use and keep this Instruction / Installation Manual for future reference.

2. Product Introduction

2.1 Top View



- 1. Max. 1800 W zone
- 2. Max. 1200 W zone
- 3. Glass plate
- 4. ON / OFF
- 5. Control panel

2.2 Control Panel

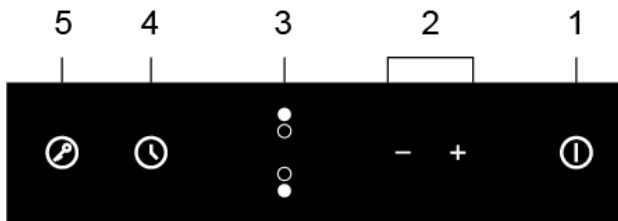

- 1. ON/OFF control
- 2. Power / Timer regulating controls
- 3. Heating zone selection controls
- 4. Timer control
- 5. Key lock control

2.3 Product Information

The microcomputer ceramic cooker hob can meet different kinds of cuisine demands because of resistance wire heating, micro-computerized control and multi-power selection, really the optimal choice for modern families.

The ceramic cooker hob centers on customers and adopts personalized design. The hob has safe and reliable performances, making your life comfortable and enabling to fully enjoy the pleasure from life.

2.4 Working Principle

This ceramic cooker hob directly employs resistance wire heating, and adjust the output power by the power regulation with the touch controls.

2.5 Before using your New Ceramic Hob

- Read this guide, taking special note of the 'Safety Warnings' section.
- Remove any protective film that may still be on your ceramic hob.

2.6 Technical Specification

Cooking Zones	2 Zones
Supply Voltage	220-240V~ 50Hz or 60Hz
Installed Electric Power	2700-3300W
Product Size D×W×H(mm)	288X520X55
Building-in Dimensions A×B (mm)	268X490

Weight and Dimensions are approximate. Because we continually strive to improve our products we may change specifications and designs without prior notice.

3. Operation of Product

3.1 Touch Controls

- The controls respond to touch, so you don't need to apply any pressure.
- Use the ball of your finger, not its tip.
- You will hear a beep each time a touch is registered.
- Make sure the controls are always clean, dry, and that there is no object (e.g. a utensil or a cloth) covering them. Even a thin film of water may make the controls difficult to operate.

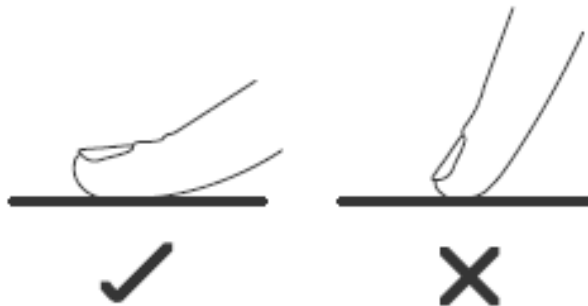

3.2 Choosing the right Cookware

Do not use cookware with jagged edges or a curved base.



Make sure that the base of your pan is smooth, sits flat against the glass, and is the same size as the cooking zone. Always centre your pan on the cooking zone.

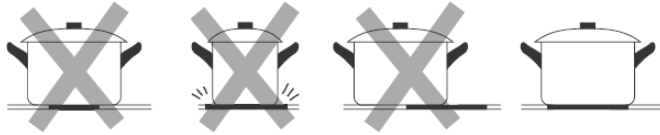

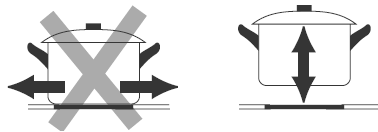

Always lift pans off the ceramic hob – do not slide, or they may scratch the glass.



3.3 How to use

3.3.1 Start cooking

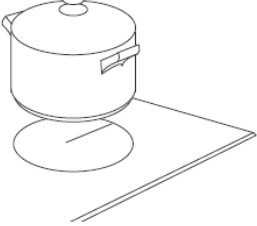
After power on, the buzzer beeps once, all the indicators light up for 1 second then go out, indicating that the ceramic hob has entered the stat of standby mode.

<p>Touch the ON/OFF control. all the indicators show “-“</p>	
<p>Place a suitable pan on the cooking zone that you wish to use.</p> <ul style="list-style-type: none"> • Make sure the bottom of the pan and the surface of the cooking zone are clean and dry. 	
<p>Touching the heating zone selection control</p>	

Select a heat setting by touching the “-” or “+” control.

- If you don't choose a heat setting within 1 minute, the ceramic hob will automatically switch off. You will need to start again at step 1.
- You can modify the heat setting at any time during cooking.
- By holding down either of these buttons, the value will adjust up or down.

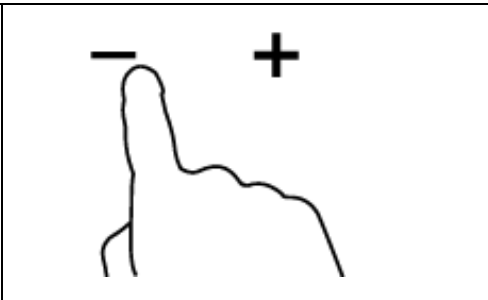

3.3.2 Finish cooking

Touching the heating zone selection control that you wish to switch off

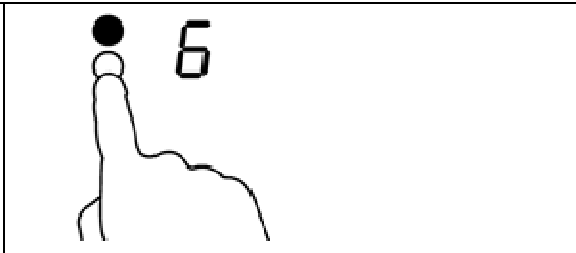

Turn the cooking zone off by scrolling down to “0” or touching “-” and “+” control together.

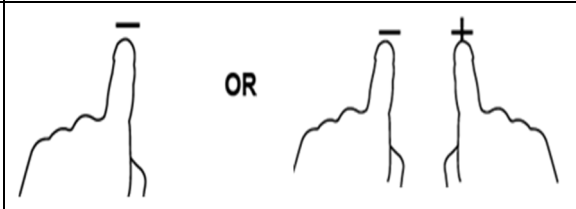

Turn the whole cooktop off by touching the ON/OFF control

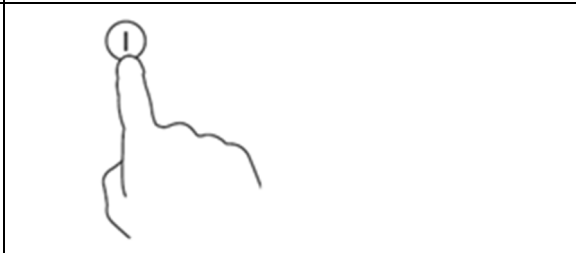

Beware of hot surfaces

“H” will show which cooking zone is hot to touch. It will disappear when the surface has cooled down to a safe temperature. It can also be used as an energy saving function if you want to heat further pans, use the hotplate that is still hot.



3.3.3 Locking the Controls

- You can lock the controls to prevent unintended use (for example children accidentally turning the cooking zones on).
- When the controls are locked, all the controls except the ON/OFF control are disabled.

To lock the controls	
Touch the lock control	The timer indicator will show “Lo “
To unlock the controls	

Make sure the ceramic hob is turned on
Touch and hold the lock control for a while.



When the hob is in the lock mode, all the controls are disabled except the ON/OFF control, you always turn the ceramic hob off with the ON/OFF control in an emergency, but you shall unlock the hob first in the next operation.

3.3.4 Timer control

You can use the timer in two different ways:

- a) You can use it as a minute minder. In this case, the timer will not turn any cooking zone off when the set time is up.
- b) You can set it to turn one or more cooking zones off after the set time is up.
- The timer of maximum is 99 minutes

a) Using the Timer as a Minute Minder

If you are not selecting any cooking zone



<p>Make sure the cooktop is turned on. Note: you can use the minute minder even if you're not selecting any cooking zone.</p>	
<p>Touch the timer control, the timer indicator will flash ; Adjust the timer setting by touch the "-" or "+" controls. The minute minder indicator will start flashing and will show in the timer display</p>	
<p>Touching the "-" and "+" together, the timer is cancelled, and the "--" will show in the minute display.</p>	
<p>When the time is set, it will begin to count down immediately. The display will show the remaining time and the timer indicator will flash for 5 seconds</p>	
<p>Buzzer will beep for 30 seconds and the timer indicator shows "--" when the setting time finished.</p>	

Hint:

- a) Touch the "-" or "+" control of the timer once to decrease or increase by 1 minute.
- b) Touch and hold the "-" or "+" control of the timer to decrease or increase by 10 minutes.
- c) If the setting time exceeds 99 minutes, the timer will automatically return to 0 minute.

b) Setting the timer to turn one or more cooking zones off

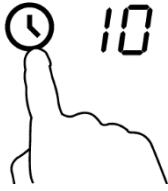
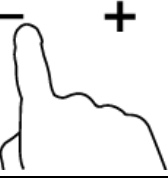
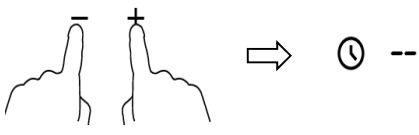
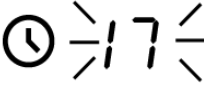
Set one zone	
<p>Touch the zone you want to set</p>	

Touch the timer control, the timer indicator show "10"	
Set the time by touching the "-" or "+" control of the timer	
Touching the "-" and "+" together, the timer is cancelled, and the will show "--" in the minute display.	
When the time is set, it will begin to count down immediately. The display will show the remaining time and the timer indicator flash for 5 seconds	
When cooking timer expires, the corresponding cooking zone will be switched off automatically. The display will show "H" which means hot;	

Note:

- a) The red dot next to power level indicator will illuminate indicating that zone is selected.

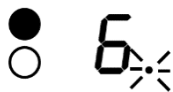

- b) If you want to change the time after the timer is set, you have to start from step 1.
- c) The method for setting two zones is the same as mentioned above.

Setting the timer to turn more than one cooking zones off

- a). If more than one heating zones use this function, the timer indicator will show the lowest time.
(e.g. zone 1# setting time of 5 minutes, zone 2# setting time of 15 minutes, the timer indicator shows "5".)
NOTE: The red dot next to power level indicator will flash.



(set to 5 minutes)



(set to 15 minutes)



- b). Once the countdown timer expires, the corresponding zone will switch off. Then it will show the new min. timer and the dot of corresponding zone will flash.

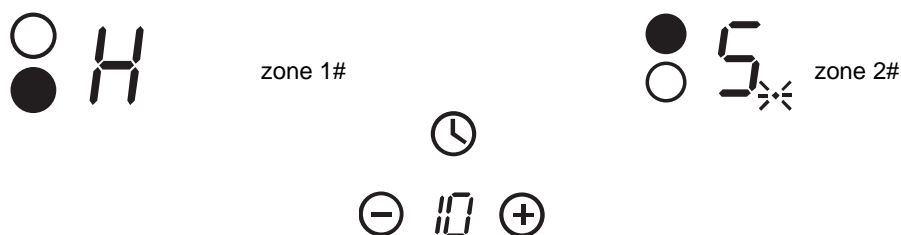

- c). When cooking timer expires, the corresponding cooking zone will be switch off automatically.



Note:

- 1) The red dot next to power level indicator will illuminate indicating that zone is selected.



- 2) If you want to change the time after the timer is set, you have to start from step 1.

3.3.5 Over-Temperature Protection

A temperature sensor equipped can monitor the temperature inside the ceramic hob. When an excessive temperature is monitored, the ceramic hob will stop operation automatically.

3.3.6 Residual Heat Warning

When the hob has been operating for some time, there will be some residual heat. The letter " H "appears to warn you to keep away from it.

3.3.7 Default working times

Another safety feature of the hob is automatic shutdown. This occurs whenever you forget to switch off a cooking zone. The default shutdown times are shown in the table below:

Power level	1	2	3	4	5	6	7	8	9
Default working timer (hour)	8	8	8	4	4	4	2	2	2

4. Cooking Guidelines



Take care when frying as the oil and fat heat up very quickly, particularly if you're using PowerBoost. At extremely high temperatures oil and fat will ignite spontaneously and this presents a serious fire risk.

4.1 Cooking Tips

- When food comes to the boil, reduce the temperature setting.
- Using a lid will reduce cooking times and save energy by retaining the heat.
- Minimize the amount of liquid or fat to reduce cooking times.
- Start cooking on a high setting and reduce the setting when the food has heated through.

4.1.1 Simmering, cooking rice

- Simmering occurs below boiling point, at around 85°C, when bubbles are just rising occasionally to the surface of the cooking liquid. It is the key to delicious soups and tender stews because the flavours develop without overcooking the food. You should also cook egg-based and flour thickened sauces below boiling point.
- Some tasks, including cooking rice by the absorption method, may require a setting higher than the lowest setting to ensure the food is cooked properly in the time recommended.

4.1.2 Searing steak

To cook juicy flavorsome steaks:

1. Stand the meat at room temperature for about 20 minutes before cooking.
2. Heat up a heavy-based frying pan.
3. Brush both sides of the steak with oil. Drizzle a small amount of oil into the hot pan and then lower the meat onto the hot pan.
4. Turn the steak only once during cooking. The exact cooking time will depend on the thickness of the steak and how cooked you want it. Times may vary from about 2 – 8 minutes per side. Press the steak to gauge how cooked it is – the firmer it feels the more ‘well done’ it will be.
5. Leave the steak to rest on a warm plate for a few minutes to allow it to relax and become tender before serving.

4.1.3 For stir-frying

1. Choose a ceramic compatible flat-based wok or a large frying pan.
2. Have all the ingredients and equipment ready. Stir-frying should be quick. If cooking large quantities, cook the food in several smaller batches.
3. Preheat the pan briefly and add two tablespoons of oil.
4. Cook any meat first, put it aside and keep warm.
5. Stir-fry the vegetables. When they are hot but still crisp, turn the cooking zone to a lower setting, return the meat to the pan and add your sauce.
6. Stir the ingredients gently to make sure they are heated through.
7. Serve immediately.

5. Heat Settings

The settings below are guidelines only. The exact setting will depend on several factors, including your cookware and the amount you are cooking. Experiment with the Ceramic hob to find the settings that best suit you.

Heat setting	Suitability
1 - 2	<ul style="list-style-type: none">• delicate warming for small amounts of food• melting chocolate, butter, and foods that burn quickly• gentle simmering• slow warming
3 - 4	<ul style="list-style-type: none">• reheating• rapid simmering

	<ul style="list-style-type: none"> • cooking rice
5 - 6	<ul style="list-style-type: none"> • pancakes
7 - 8	<ul style="list-style-type: none"> • sautéing • cooking pasta
9	<ul style="list-style-type: none"> • stir-frying • searing • bringing soup to the boil • boiling water

6. Care and Cleaning

What?	How?	Important!
Everyday soiling on glass (fingerprints, marks, stains left by food or non-sugary spillovers on the glass)	<ol style="list-style-type: none"> 1. Switch the power to the cooktop off. 2. Apply a cooktop cleaner while the glass is still warm (but not hot!) 3. Rinse and wipe dry with a clean cloth or paper towel. 4. Switch the power to the cooktop back on. 	<ul style="list-style-type: none"> • When the power to the cooktop is switched off, there will be no 'hot surface' indication but the cooking zone may still be hot! Take extreme care. • Heavy-duty scourers, some nylon scourers and harsh/abrasive cleaning agents may scratch the glass. Always read the label to check if your cleaner or scourer is suitable. • Never leave cleaning residue on the cooktop: the glass may become stained.
Boilovers, melts, and hot sugary spills on the glass	<p>Remove these immediately with a fish slice, palette knife or razor blade scraper suitable for Ceramic glass cooktops, but beware of hot cooking zone surfaces:</p> <ol style="list-style-type: none"> 1. Switch the power to the cooktop off at the wall. 2. Hold the blade or utensil at a 30° angle and scrape the soiling or spill to a cool area of the cooktop. 3. Clean the soiling or spill up with a dish cloth or paper towel. 4. Follow steps 2 to 4 for 'Everyday soiling on glass' above. 	<ul style="list-style-type: none"> • Remove stains left by melts and sugary food or spillovers as soon as possible. If left to cool on the glass, they may be difficult to remove or even permanently damage the glass surface. • Cut hazard: when the safety cover is retracted, the blade in a scraper is razor-sharp. Use with extreme care and always store safely and out of reach of children.
Spillovers on the touch controls	<ol style="list-style-type: none"> 1. Switch the power to the cooktop off. 2. Soak up the spill 3. Wipe the touch control area with a clean damp sponge or cloth. 4. Wipe the area completely dry with a paper towel. 5. Switch the power to the cooktop back on. 	<ul style="list-style-type: none"> • The cooktop may beep and turn itself off, and the touch controls may not function while there is liquid on them. Make sure you wipe the touch control area dry before turning the cooktop back on.

7. Hints and Tips

Problem	Possible causes	What to do
The cooktop cannot be turned on.	No power.	Make sure the ceramic hob is connected to the power supply and that it is switched on. Check whether there is a power outage in your home or area. If you've checked everything and the problem persists, call a qualified technician.
The touch controls are unresponsive.	The controls are locked.	Unlock the controls. See section 'Using your ceramic cooktop' for instructions.
The touch controls are difficult to operate.	There may be a slight film of water over the controls or you may be using the tip of your finger when touching the controls.	Make sure the touch control area is dry and use the ball of your finger when touching the controls.
The glass is being scratched.	Rough-edged cookware. Unsuitable, abrasive scourer or cleaning products being used.	Use cookware with flat and smooth bases. See 'Choosing the right cookware'. See 'Care and cleaning'.
Some pans make crackling or clicking noises.	This may be caused by the construction of your cookware (layers of different metals vibrating differently).	This is normal for cookware and does not indicate a fault.

8. Installation

8.1 Selection of installation equipment

1. Cut out the work surface according to the sizes shown in the drawing.

For the purpose of installation and use, a minimum of 50mm space shall be preserved around the hole. Be sure the thickness of the work surface is at least 30mm. Please select heat-resistant and insulated work surface material (Wood and similar fibrous or hygroscopic material shall not be used as work surface material unless impregnated) to avoid the electrical shock and larger deformation caused by the heat radiation from the hotplate. As shown below:



Note: The safety distance between the sides of the hob and the inner surfaces of the worktop s be at least 3mm.

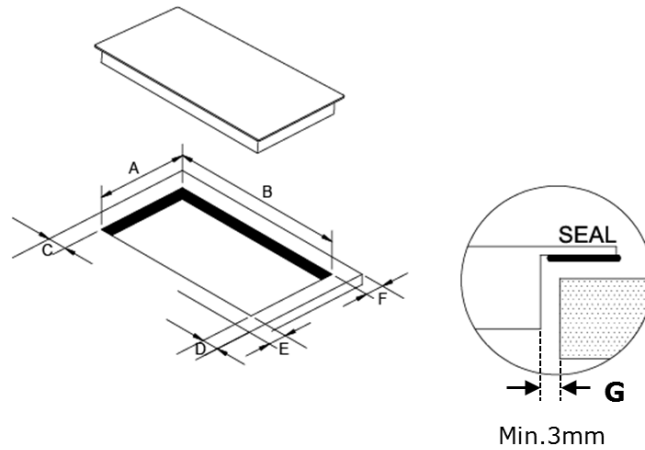

A	B	C	D	E	F	G
268 ⁺⁴ -0 mm	490 ⁺⁴ -0 mm	50mm mini	50mm mini	50mm mini	50mm mini	3mm mini

2. The ceramic cooker hob can be used on the table top of cabinet. The ceramic hob should be placed horizontally. As shown below:

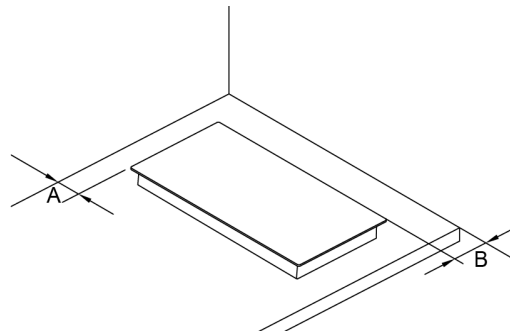

A	B
50mm mini	50mm mini

Under any circumstances, make sure the ceramic cooker hob is well ventilated and the air inlet and outlet are not blocked. Ensure the ceramic cooker hob is in good work state. As shown below



Note: The safety distance between the hotplate and the cupboard above the hotplate should be at least 760mm.

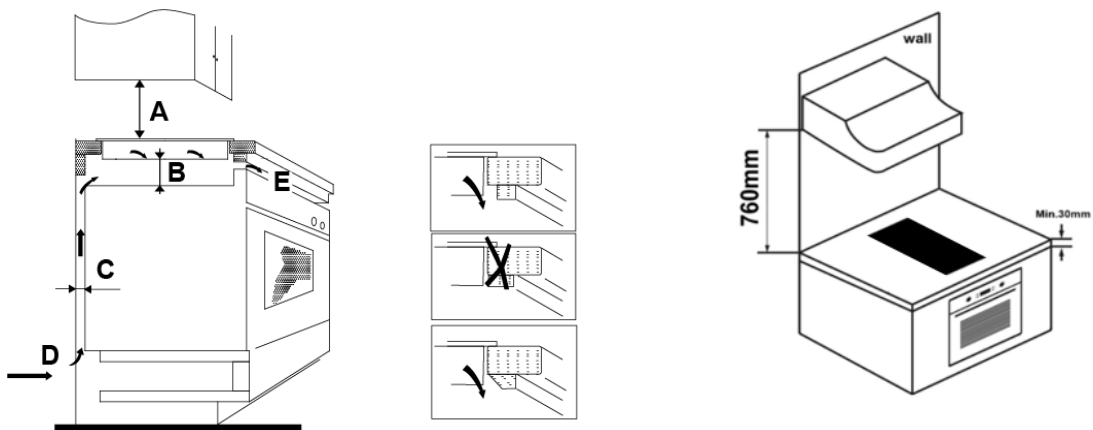

A(mm)	B(mm)	C(mm)	D	E
760	50 mini	20 mini	Air intake	Air exit 5mm

WARNING: Ensuring Adequate Ventilation

Make sure the ceramic hob is well ventilated and that air inlet and outlet are not blocked. In order to avoid accidental touch with the overheating bottom of the hob, or getting unexpected electric shock during working, it is necessary to put a wooden insert, fixed by screws, at a minimum distance of 50mm from the bottom of the hob. Follow the requirements below.

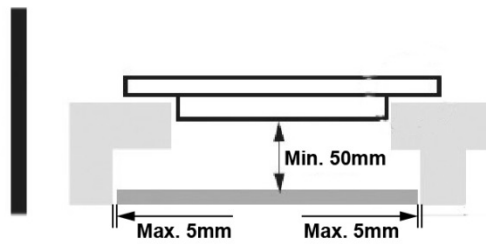

There are ventilation holes around outside of the hob. YOU MUST ensure these holes are not blocked by the worktop when you put the hob into position.



- Be aware that the glue that join the plastic or wooden material to the furniture, has to resist to temperature not below 150°C, to avoid the unstuck of the paneling.
- The rear wall, adjacent and surrounding surfaces must therefore be able to withstand an temperature of 90°C.

8.2 Before locating the fixing brackets

The unit should be placed on a stable, smooth surface (use the packaging). Do not apply force onto the controls protruding from the hob.

Fix the hob on the work surface by screw four brackets on the bottom of hob (see picture) after installation. Adjust the bracket position to suit for different work surface's thickness.

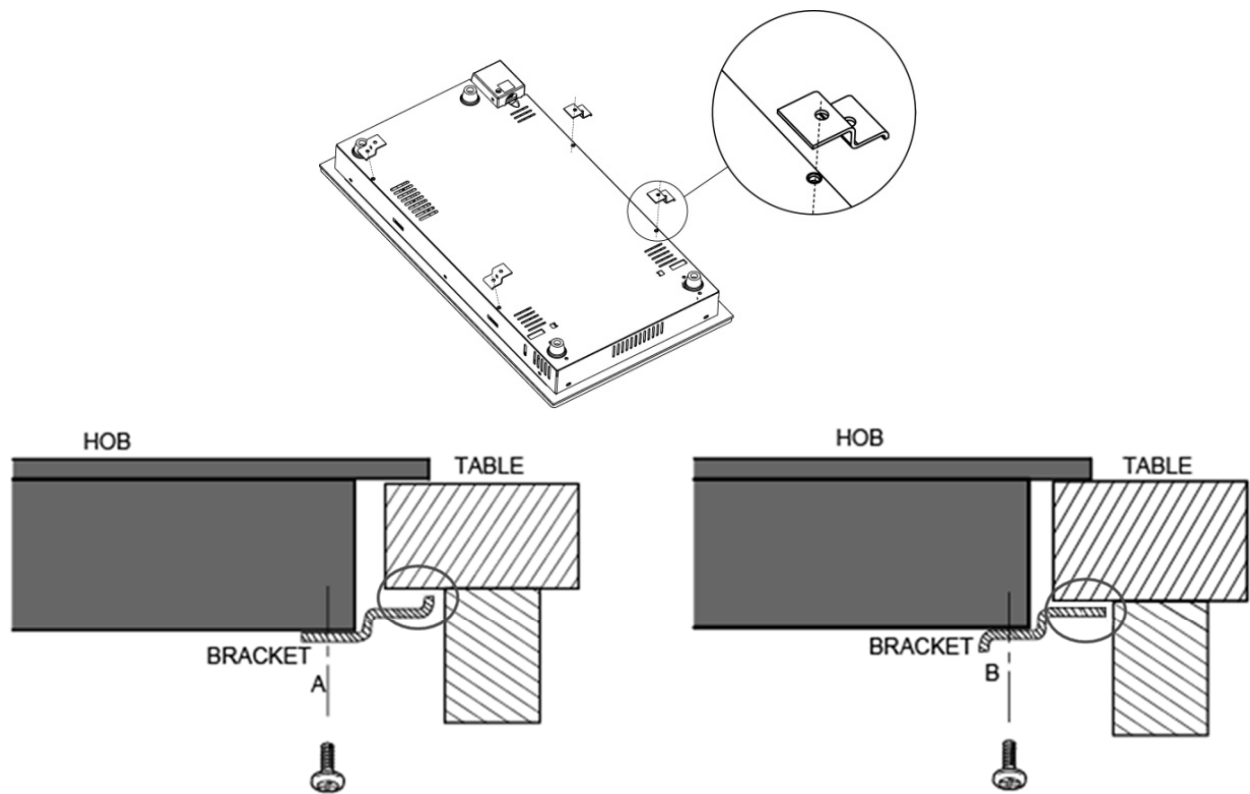

Under any circumstances, the brackets cannot touch with the inner surfaces of the worktop after installation (see picture).

8.3 Cautions

1. The ceramic cooker hob must be installed by qualified personnel or technicians. We have professionals at your service. Please never conduct the operation by yourself.
2. The ceramic cooker hob shall not be mounted to cooling equipment, dishwashers and rotary dryers.
3. The ceramic cooker hob shall be installed such that better heat radiation can be ensured to enhance its reliability.
4. The wall and induced heating zone above the work surface shall withstand heat.
5. To avoid any damage, the sandwich layer and adhesive must be resistant to heat.
6. A steam cleaner is not to be used.
7. This ceramic can be connected only to a supply with system impedance no more than 0.427 ohm. In case necessary, please consult your supply authority for system impedance information.

8.4 Connecting the hob to the mains power supply

The power supply should be connected in compliance with the relevant standard, or a single-pole circuit breaker. The method of connection is shown below.

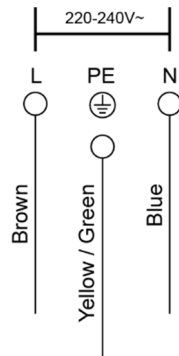

1. If the cable is damaged or needs replacing, this should be done by an after-sales technician using the proper tools, so as to avoid any accidents.
2. If the appliance is being connected directly to the mains supply, an omnipolar circuit breaker must be installed with a minimum gap of 3mm between the contacts.
3. The installer must ensure that the correct electrical connection has been made and that it complies with safety regulations.
4. The cable must not be bent or compressed.
5. The cable must be checked regularly and only replaced by a properly qualified person.



The bottom surface and the power cord of the hob are not accessible after installation.

 <p>DISPOSAL: Do not dispose this product as unsorted municipal waste. Collection of such waste separately for special treatment is necessary.</p>	<p>This appliance is labeled in compliance with European directive 2012/19/EU for Waste Electrical and Electronic Equipment (WEEE). By ensuring that this appliance is disposed of correctly, you will help prevent any possible damage to the environment and to human health, which might otherwise be caused if it were disposed of in the wrong way.</p> <p>The symbol on the product indicates that it may not be treated as normal household waste. It should be taken to a collection point for the recycling of electrical and electronic goods.</p> <p>This appliance requires specialist waste disposal. For further information regarding the treatment, recover and recycling of this product please contact your local council, your household waste disposal service, or the shop where you purchased it.</p> <p>For more detailed information about treatment, recovery and recycling of this product, please contact your local city office, your household waste disposal service or the shop where you purchased the product.</p>
--	---



KONČAR - KUĆANSKI APARATI d.d.

Slavonska avenija 16 , 10001 Zagreb , Hrvatska

tel : ++ 385 1/2484 555

fax : ++ 385 1/2404 102

www.koncar-ka.hr